

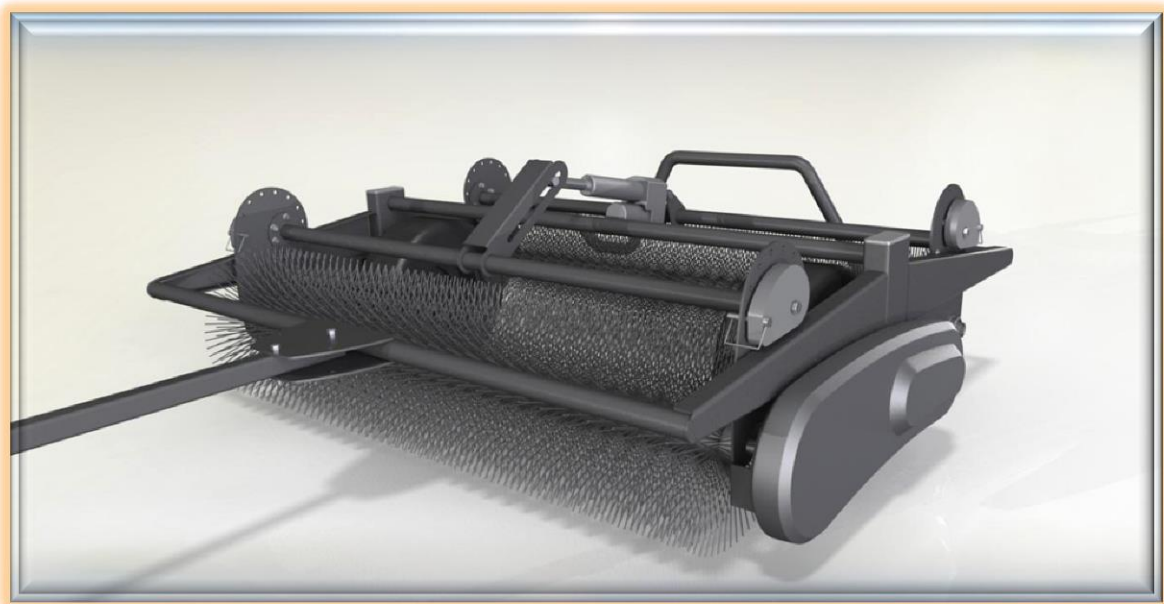

## Owner's & Operator's Manual



**SGM Industries, LLC**

**TB 220™ Turf Brush**

It is imperative for your safety that you read and understand these instructions before operating the TB 220™ Turf Brush. If you have any questions please contact SGM Industries, LLC at the address below. Keep these instructions in a convenient place for future reference.

### SGM Industries, LLC

1875 Ridgemont Court  
Montgomery, IL 60538  
Phone: 630.688.5192  
[jeff.scott@sgmindustries.com](mailto:jeff.scott@sgmindustries.com)  
[sgmindustries.com](http://sgmindustries.com)

## Overview

- The TB 220™ Turf Brush is the second generation grooming tool with two cylindrical brushes which rotate in the same direction. The unit is used by groundskeepers to improve the appearance, quality, and the growing conditions of turf on golf courses and numerous sports fields. Various vehicles can be used to tow the brush such as lightweight tractors and utility vehicles.
- The TB 220™ Turf Brush can be used in several different applications. Utilized as a groomer, the brush will lift up the bent-over grass blades so that a mower can cleanly cut them. The brush can also be used to incorporate topdressing materials into the canopy of the turf. The rotating action of the brushes integrates the topdressing much deeper into the canopy so the materials are not removed the next time the turf is mowed. The TB 220™ Turf Brush is a superb tool for backfilling materials into holes left in the turf after an aeration operation has been completed.
- Both brushes will begin to rotate as the unit is pulled along the ground.
- To travel from work area to work area, the operator raises the brushes by means of a high speed electric actuator. This lifts the brushes to a safe distance above the turf.
- A new feature of the TB 220™ Turf Brush is the ability to remove aerifier cores from the green surface. The TB 220™ Turf Brush will move a surprisingly large amount of sand or topdressing material and now, due to the fully enclosed and sealed side covers, aerifier core removal should not present a problem.

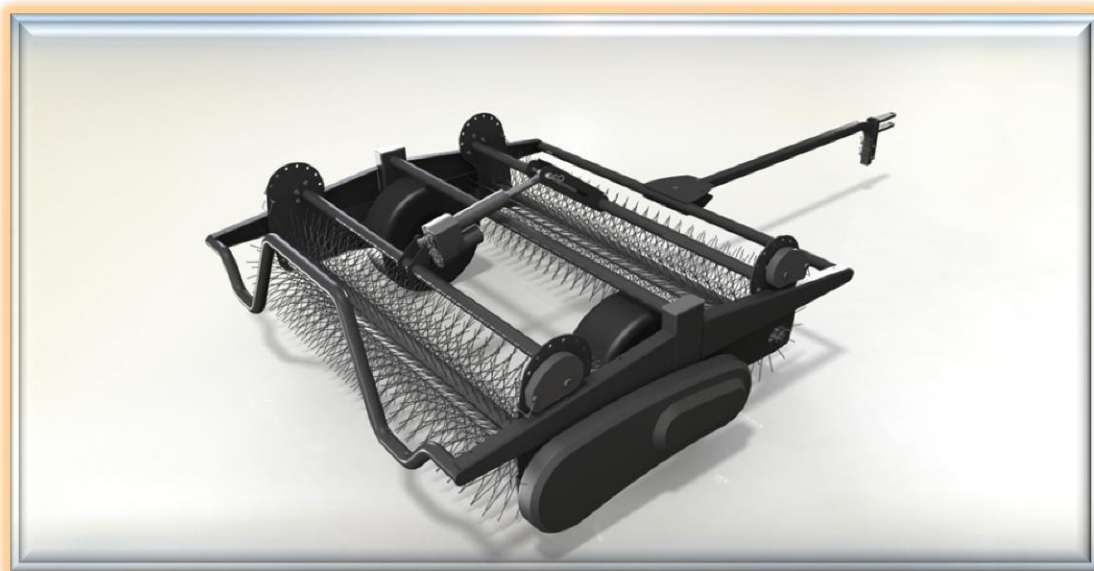

# Safety Information

As an owner or operator of the TB 220™ Turf Brush, it is extremely important that you read and understand the contents of this manual before attempting to use the brush. The operator is ultimately responsible for his/her safety as well as the safety of others nearby. Any piece of equipment with moving parts is potentially hazardous. There is no substitute for an operator who recognizes the potential hazards and follows sensible safety practices.

## Equipment Safety Guidelines

- Read and understand the owner's manual before attempting to use the brush.
- Do not consume alcoholic beverages or drugs while operating the TB 220™ Turf Brush. Consult your doctor about any prescription medications before operating the unit.
- Keep all safety devices, guards, and decals in place and functional. Replace or repair any items as needed before operation.
- Review all safety instructions with all users on an annual basis.
- Wear approved safety shoes and safety glasses when using the unit.
- Keep unauthorized people away from the areas of operation.
- Never allow children to operate the brush.
- Do not wear loose clothing that could become entangled in moving parts.
- Be sure the work area is free of debris and loose objects.
- The brush is not intended for riders.
- Raise the brushes off the ground properly for transport to prevent damage.
- Avoid excessive speed during operation. Use extreme caution and maintain minimum speed when traveling on hillsides, rough terrain, or near drop-offs. Do not make sharp turns and/or traverse steep slopes. Care should be used when traveling up or down hills.
- Shut off the tow vehicle and set the parking brake when leaving the brush unattended.
- Never work under any equipment unless it is blocked up correctly.
- Check and tighten all fasteners as needed.
- The warranty and the liability of the manufacturer are voided if any alteration of the equipment is performed.
- The TB 220™ Turf Brush should be stored away in a safe location after use. If you are storing the unit on the rear bumper, be sure the ground is level and able to support the brush. A concrete floor is recommended. Brace the unit to an adjacent wall to eliminate possible tipping.

## Assembly and Setup

The TB 220™ Turf Brush is very straightforward to setup. Very few assembly steps are required. Follow the instructions below and you will be ready to operate the brush.

- Assemble the hitch tube (1) to the frame (36) using the hex bolts and nuts (20 & 17) provided. (Image A) Tighten these fasteners securely.
- Attach the unit to the desired tow vehicle. Adjust the position of the hitch weldment (24), using the two quick-release lynch pins (7), until the hitch tube (1) is parallel to the ground. (Image B) It is important to perform this setup on a level and flat surface. The hitch weldment (24) and the hitch tube (1) can both be positioned in two different orientations to encompass a large range of tow vehicles.
- Connect the actuator control box harness assembly to the brush harness. Route the cable as needed so it does not become tangled or allowed to catch on anything during use. The red battery clip should be attached to the positive lug on the tow vehicle battery, and the black battery clip is connected to the negative lug.
- Check the tires for proper inflation of 14 psi (97 kPa).
- The TB 220™ Turf Brush comes from the factory with all initial lubrication already performed. The brushes are set in the lockout position for shipping. Please see page 5 for information on adjusting brush height.



Image A



Image B

## General Operation

- The TB 220™ Turf Brush should always be transported by raising the brushes off the ground using the actuator. This is easily accomplished by pressing up on the actuator switch until the brushes are fully raised. A clicking sound will be heard in the actuator when the maximum up and down positions are reached.
- Do not exceed 10 mph (24 km/h) when transporting the unit.
- The brush height should be set to the third hole for normal use. The user can change this depending on his/her needs by simply pulling the lynch pin (7) and positioning it in a different hole in the brush support weldment (37 & 38). (See Image C) Although there are 8 holes available, holes 1 through 4 should be the main holes used depending on the brushing procedure being performed at the time. Use holes 1 or 2 to set the brush more aggressive, hole 3 as a middle setting, and hole 4 to set the brush less aggressive. When adjusting brush height, there is no need to make any chain adjustments. The front or rear brushes can be positioned in the lockout hole if the user wishes to only run one brush for a less aggressive application.
- SGM Industries, LLC recommends that the unit be stored inside when not in use. The rear bumper is designed to allow this. The unit can be rotated up into a vertical position for storage. Be sure the ground is level and able to support the brush. A concrete floor is recommended. Brace the unit to an adjacent wall to eliminate possible tipping. If storing in this method, do not try to lift the unit by yourself. This is a two person operation. Lower the unit slowly to prevent damage.
- Do not store the unit with the brushes in contact with the ground. This can cause the brushes to become deformed.

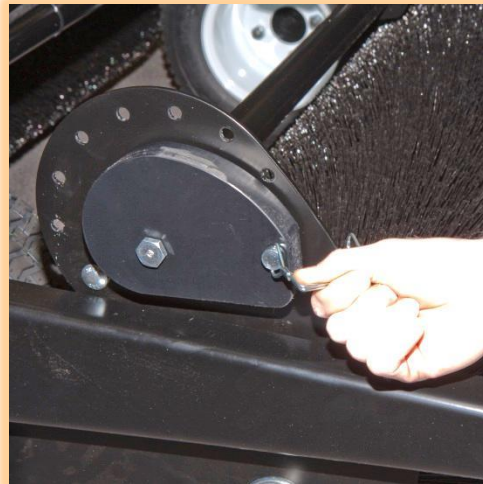
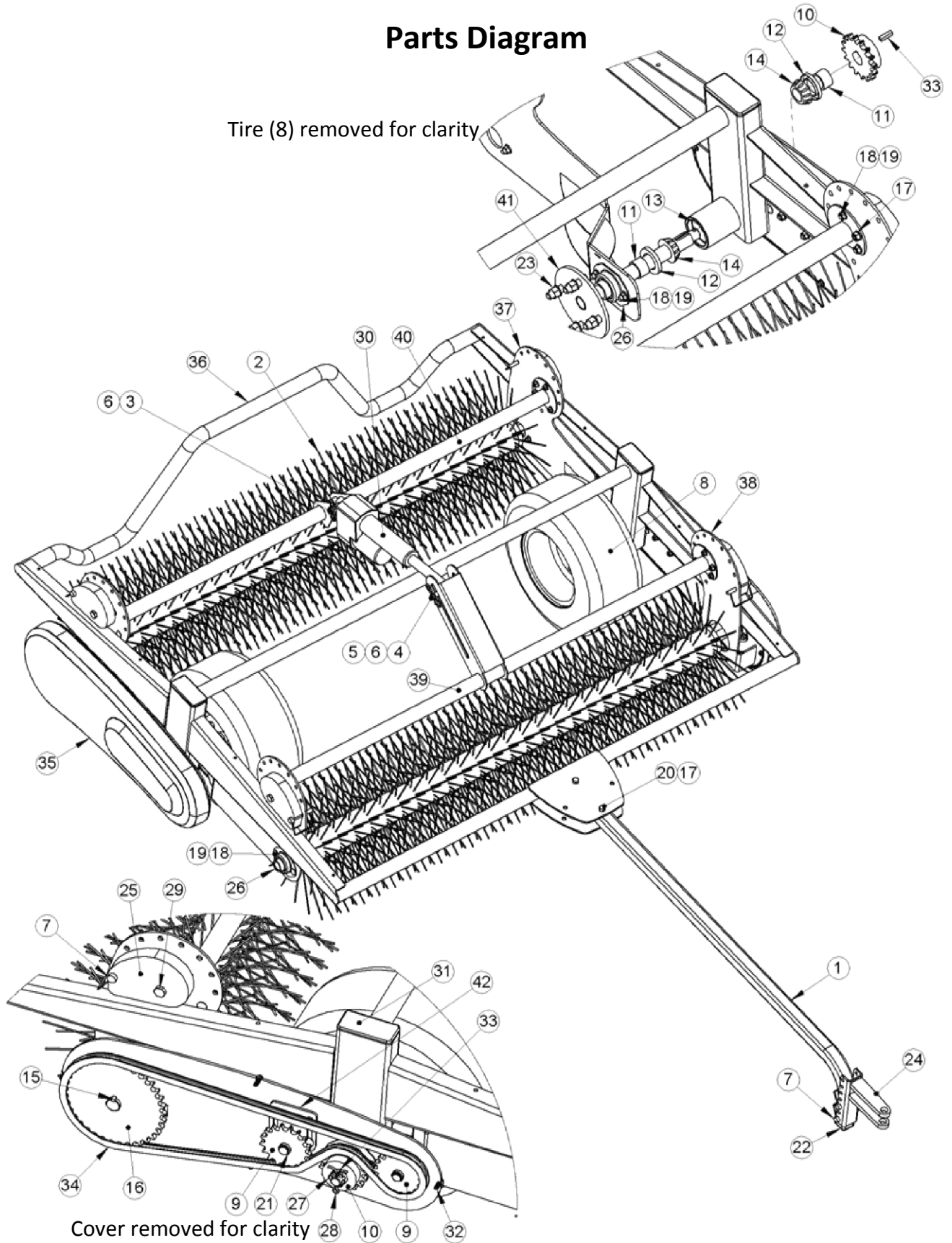

Image C

# Parts Diagram

Tire (8) removed for clarity



# Bill of Materials

| Item No.  | Part Number | Description                              | Quantity |
|-----------|-------------|--|----------|
| 1         | SGM02-002   | Hitch Arm Tube                           | 1        |
| 2         | SGM02-004   | Brush Assembly                           | 2        |
| 3         | SGM02-110   | Clevis Pin, .50 x 2.75                   | 1        |
| 4         | SGM02-111   | Clevis Pin, .50 x 3.5                    | 1        |
| 5         | SGM02-112   | Spacer, Actuator                         | 2        |
| 6         | SGM02-113   | Cotter Pin, Bow Tie                      | 2        |
| 7         | SGM02-114   | Pin, Wire Locking                        | 6        |
| 8         | SGM02-117   | Brush Drive Tire                         | 2        |
| 9         | SGM02-119   | Sprocket, Idler, 17 Tooth .635 Bore      | 4        |
| 10        | SGM02-120   | Sprocket, Drive Wheel, 16 Tooth 1.0 Bore | 2        |
| 11        | SGM02-121   | Spacer, Drive Wheel                      | 4        |
| 12        | SGM02-122   | Bearing Seal                             | 4        |
| 13        | SGM02-123   | Bearing Race                             | 4        |
| 14        | SGM02-124   | Bearing, Drive Wheel                     | 4        |
| 15        | SGM02-125   | Key, .25 x 1.25                          | 2        |
| 16        | SGM02-126   | Sprocket, Brush, 36 Tooth 1.0 Bore       | 2        |
| 17        | SGM02-133   | Hex Nut, Keps, 3/8-16                    | 6        |
| 18        | SGM02-134   | Carriage Bolt, 5/16-18 x .75             | 32       |
| 19        | SGM02-135   | Hex Nut, Keps, 5/16-18                   | 32       |
| 20        | SGM02-137   | 3/8-16 x 2.5 HH Cap Screw                | 2        |
| 21        | SGM02-140   | External Retaining Ring                  | 4        |
| 22        | SGM02-142   | Tube Cap, Square                         | 1        |
| 23        | SGM02-146   | Brush Drive Wheel Lug Nut, 1/2-20        | 8        |
| Not Shown | SGM02-147   | Fuse, 25 Amp Mini ATM Automotive         | 1        |
| 24        | SGM02-304   | Hitch Weldment                           | 1        |
| 25        | SGM03-010   | Cam, Height Stop                         | 4        |
| 26        | SGM03-011   | Bearing, Flanged                         | 8        |
| 27        | SGM03-012   | 3/4-16 Castle Nut                        | 2        |
| 28        | SGM03-013   | Cotter Pin                               | 2        |
| 29        | SGM03-014   | 1/2 Diameter Shoulder Screw              | 4        |
| 30        | SGM03-015   | Actuator TB220                           | 1        |
| 31        | SGM03-016   | Tube Cap, Rectangular                    | 2        |
| 32        | SGM03-017   | 1/4-20 x .50 BH Machine Screw            | 8        |
| 33        | SGM03-018   | Key, .25 x .75                           | 2        |
| 34        | SGM03-019   | Chain W/ Master Link                     | 2        |
| 35        | SGM03-020   | Chain Cover                              | 2        |
| 36        | SGM03-300   | Frame Weldment                           | 1        |
| 37        | SGM03-301   | Brush Support Weldment, Floating         | 2        |
| 38        | SGM03-302   | Brush Support Weldment, Driving          | 2        |
| 39        | SGM03-303   | Actuator Tube Weldment, Front            | 1        |
| 40        | SGM03-304   | Actuator Tube Weldment, Rear             | 1        |
| 41        | SGM03-305   | Brush Drive Axle Weldment                | 2        |
| 42        | SGM03-306   | Tensioner Shaft Weldment                 | 2        |
| Not Shown | SGM03-310   | Control Box Harness                      | 1        |
| Not Shown | SGM03-311   | Tow Vehicle Harness                      | 1        |
| Not Shown | SGM03-312   | Brush Frame Harness                      | 1        |

# Electrical Schematic Diagram

Below is the electrical schematic for the TB 220™ Turf Brush. Please use this to troubleshoot any electrical issue you may have. The fuse is a 25 amp mini ATM automotive.

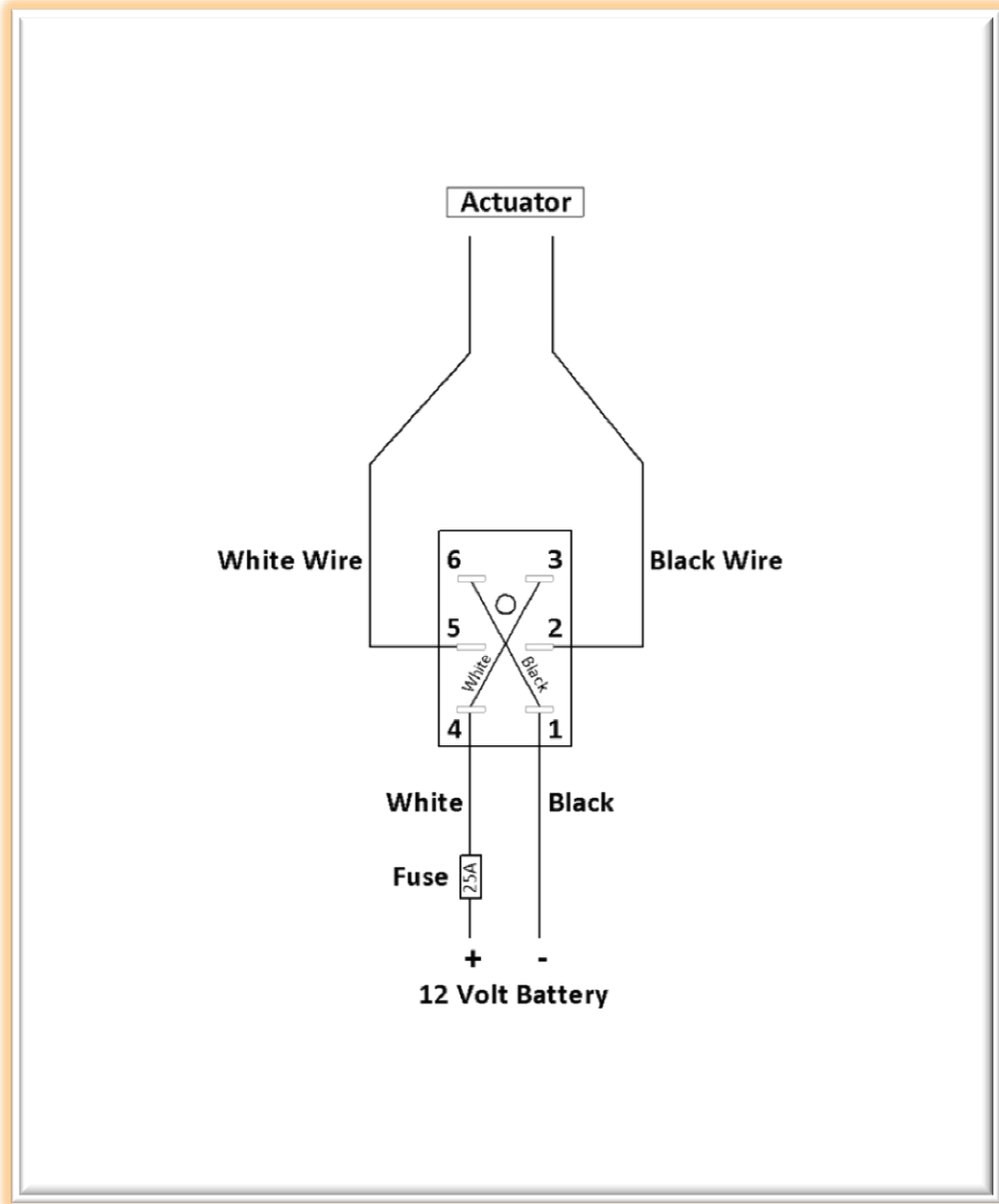



## Maintenance

The TB 220™ Turf Brush was designed to be a low maintenance product. Please follow the service procedures outlined below to keep your brush running in top condition.

- Check the tire pressure regularly and keep them inflated to 14 psi (97 kPa).
- The chain cover (35) should be removed periodically and checked for any build-up of debris. Clean this out as needed. While the cover is removed, check the chain (34) tension. There should be a sag in the top chain of ½" to 1". Adjust the tensioner shaft weldment (42) as necessary. The chain should also be lightly coated with a dry silicone spray. Reinstall the cover. Never operate the unit with the chain covers removed.
- Watch for loose hardware, pins, or fasteners. Tighten as necessary.
- The TB 220™ Turf Brush should be washed as needed using soap and water to remove any debris or dirt.
- The drive tire bearings (14) should be checked on an annual basis and re-packed with a quality wheel bearing grease if necessary.
- The electrical system is protected by a 25 amp mini ATM automotive fuse, located just ahead of the red battery clip.
- Repair parts are readily available from the factory.

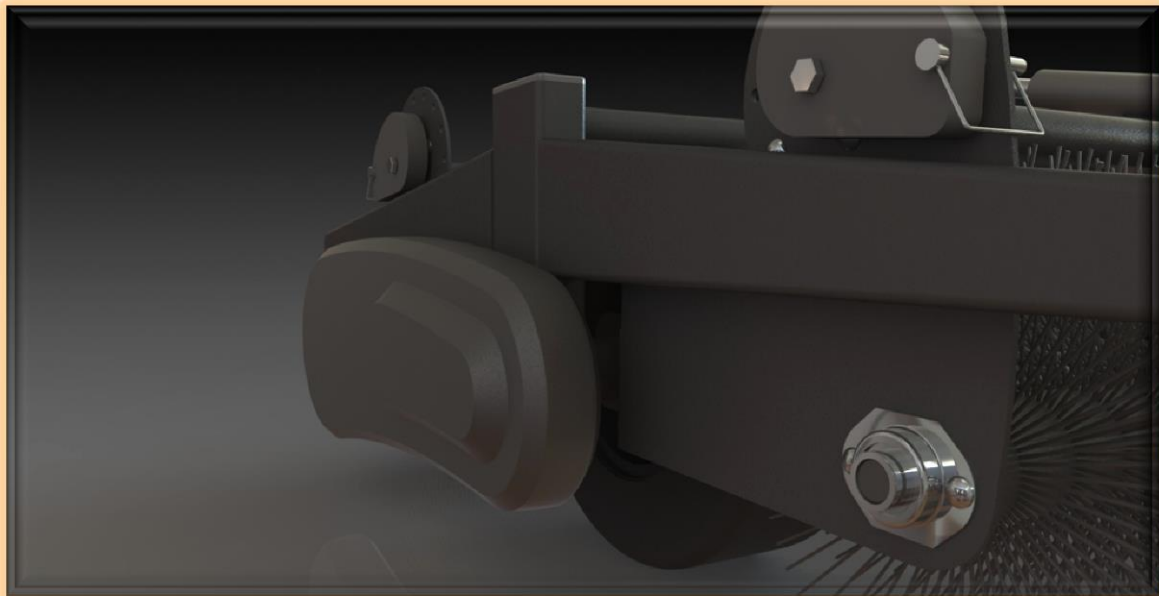

# Declaration of Conformity

SGM Industries, LLC, declares that the product detailed below complies with the requirements of the following EU directives:

- Machinery Directive 2006/42/EC
- Electromagnetic Compatibility Directive 2004/108/EC



Equipment description: Commercial Turf Brush  
Model Number: TB 220™ Turf Brush

Compliance with the essential health and safety requirements has been assessed with reference to the following harmonized standards:

- EN ISO 12100:2010 – Safety of machinery – General principles for design – Risk assessment and risk reduction.

Technical documentation for the equipment is maintained by the manufacturer and a copy kept by the EU authorized representative.

Signed on behalf  
of the manufacturer

 17 Feb 2011

Deno Minas  
President  
West Bend, February 2011

SGM Industries, LLC  
1875 Ridgmont Court  
Montgomery, IL 60538  
United States of America  
630-688-5192

Signed on behalf of the EU  
authorized representative

 26 Feb 2011

Keith Kensett  
Director  
Caterham, February 2011

R & K Kensett Ltd.  
The Officers Mess, Coldstream Road  
Caterham, Surrey CR3 5QX  
United Kingdom  
630-688-5192

## Statement of Policy

SGM Industries, LLC has always taken the initiative to improve its products where possible and practical to do so. SGM Industries, LLC reserves the right to make changes and improvements to the design and construction at any time without incurring the requirement to make these changes on previously manufactured products.

## Limited Warranty

SGM Industries, LLC (supplier) makes no representations or warranties, express or implied (including implied warranties of merchantability or fitness), except equipment shall be warranted against faulty workmanship and material for two (2) years from date of purchase. All parts supplied by other manufacturers which are used on supplier's equipment will carry the manufacturer's warranty only. The distributor agrees to deliver to purchasers at the time of each sale the documents containing the express limited warranty. The distributor is not authorized to assume for supplier any additional obligations or liabilities in connection with the sale of equipment, and the distributor agrees not to do so. Supplier and distributor shall promptly fulfill their respective obligations with respect to any warranty claims.

The obligation of the supplier under this warranty is limited to providing for the repair or replacement, in accordance with the warranty adjustments policies of the supplier, of any part or parts that prove, in the supplier's judgment, to be defective in material or workmanship within two (2) years after delivery of equipment to the original purchaser.

This warranty shall be void if any part or parts not manufactured or provided by the supplier are used either in maintaining or servicing of the equipment covered by this warranty. No warranty whatsoever is made on used, second-hand, altered or rebuilt equipment.

## Responsibility

The supplier does not accept any responsibility for damage or harm caused by not strictly observing the safety requirements and instructions detailed in this manual. The manufacturer cannot be liable for damage, injury, or consequential loss resulting from use or servicing by unqualified personnel. The manufacturer will also not be liable for damage, injury, or consequential loss resulting from inappropriate operation or modification of the equipment.

## TB 220™ Turf Brush

Made with pride in the USA

U.S. Patent No. 9,185,850

